

EXERCISE 3A

INSTRUCTIONS:

1. Start a **NEW** file using **2013-Workbook Helper.dwt**.
2. **Draw** the **LINES** below using:
 - A. **Line** command
 - B. **Ortho** (F8) **ON**.
 - C. Turn **Increment Snap** (F9) **ON**
3. Select the appropriate layer, then select the Line command, then draw a line.
4. Select the appropriate layer, then select the Line command, then draw a line.
5. Select the appropriate layer, then select the Line command, then draw a line.

Are you noticing a pattern here?
6. **Save** the drawing as: **EX3A**

Do not
enter text.

You will
learn Text
soon.

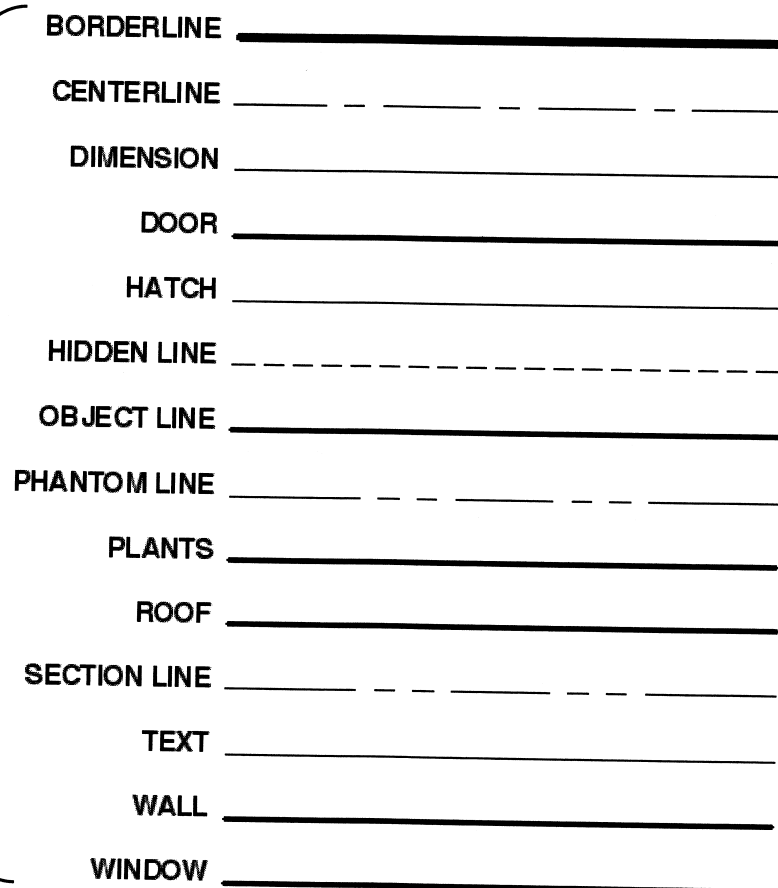

EXERCISE 3B

INSTRUCTIONS:

1. Start a **NEW** file using **2013-Workbook Helper.dwt**.
2. Change the **Increment Snap** to **.20** and **Grid spacing** to **.40**
If you have the Snap and Grids set correctly it will be easy.
3. Make sure **SNAP** and **GRID** status bar buttons are **ON**.
4. Draw the objects below using **layer Object Line**.
Review pages 3-2 through 3-6 for Circle and Rectangle options.
5. **Do not dimension**, you will learn dimensioning soon.
6. **Save** the drawing as: **EX3B**

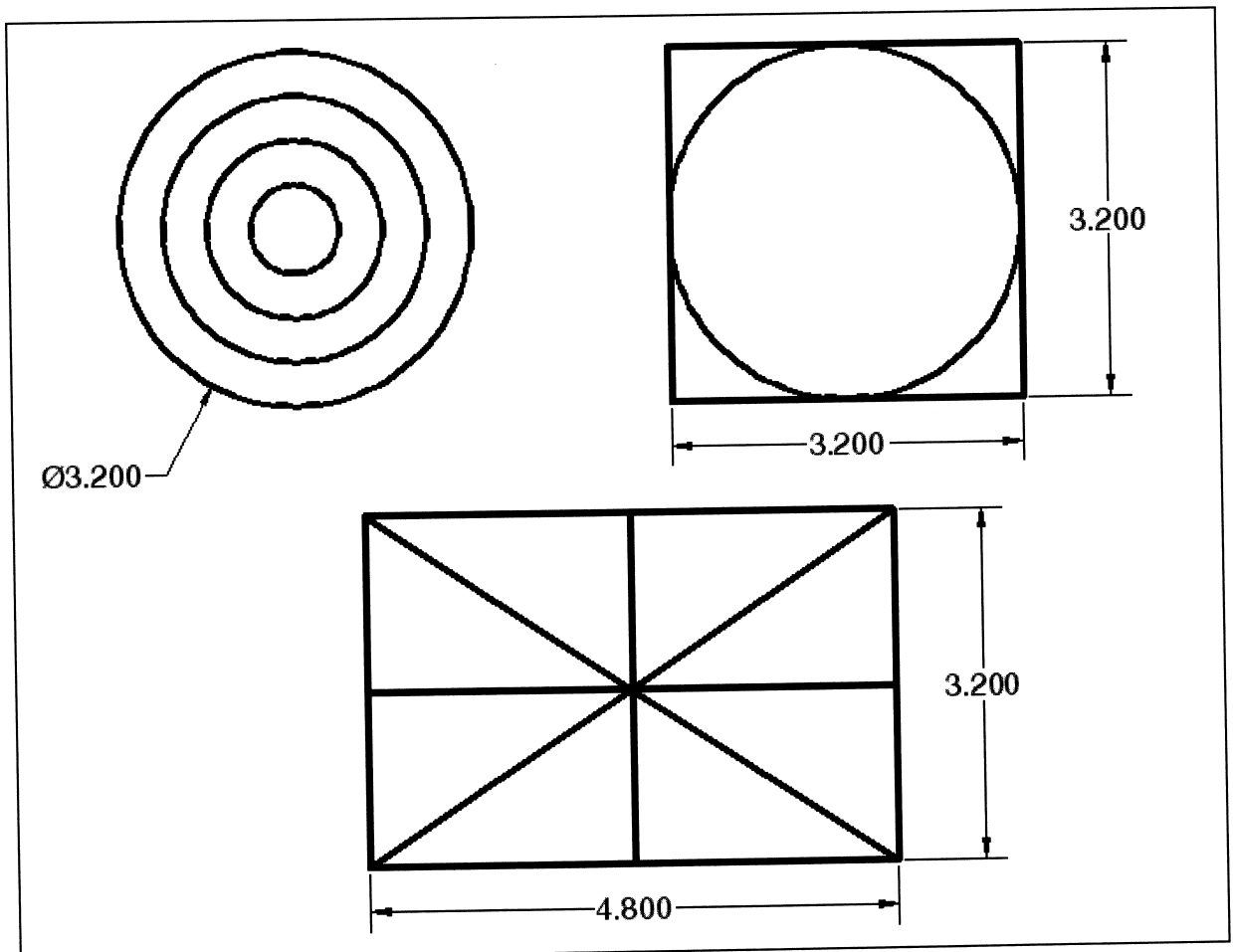

EXERCISE 3C

INSTRUCTIONS:

1. Start a **NEW** file using **2013-Workbook Helper.dwt**.
2. **Draw the Rectangles** below using the options:
Dimension, Chamfer, Fillet, Width and Rotation
3. Use layer **Object Line**.
4. **Save** the drawing as: **EX3C**

Rectangle Dimensions: Length = 3 Width = 2
Chamfer = Dist1 = .50 Dist2 = .50

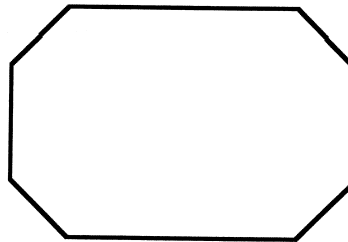

Rectangle Dimensions: Length = 3 Width = 2
Fillet = .50

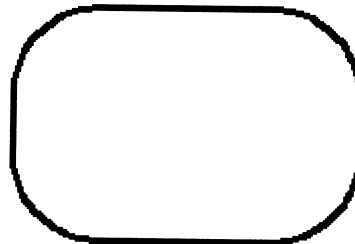

Rectangle Dimensions: Length = 3 Width = 2
Rotation = 45
Chamfer = 0
Fillet = 0

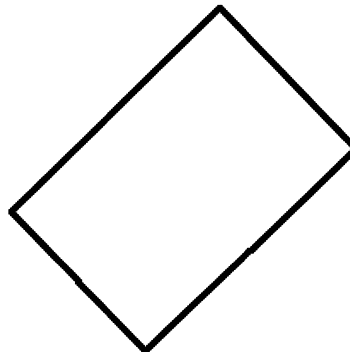

Rectangle Dimensions: Length = 3 Width = 2
Width = .200
Rotation = 0
Chamfer = 0
Fillet = 0

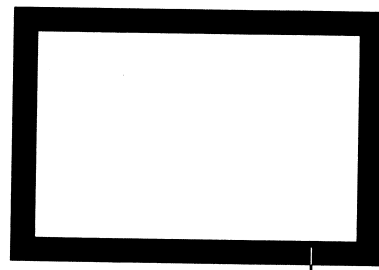

EXERCISE 3D

INSTRUCTIONS:

1. Start a **NEW** file using **2013-Workbook Helper.dwt**.
2. **Important, important:** Draw the objects below using the following Layers:
Roof, Wall, Window, Door and Plants
3. You can change Snap and Grid settings to whatever you like.
4. You decide when to turn Ortho and Snap ON or OFF.
5. All objects must be placed accurately. All lines must intersect exactly.
6. **Save** the drawing as: **EX3D**

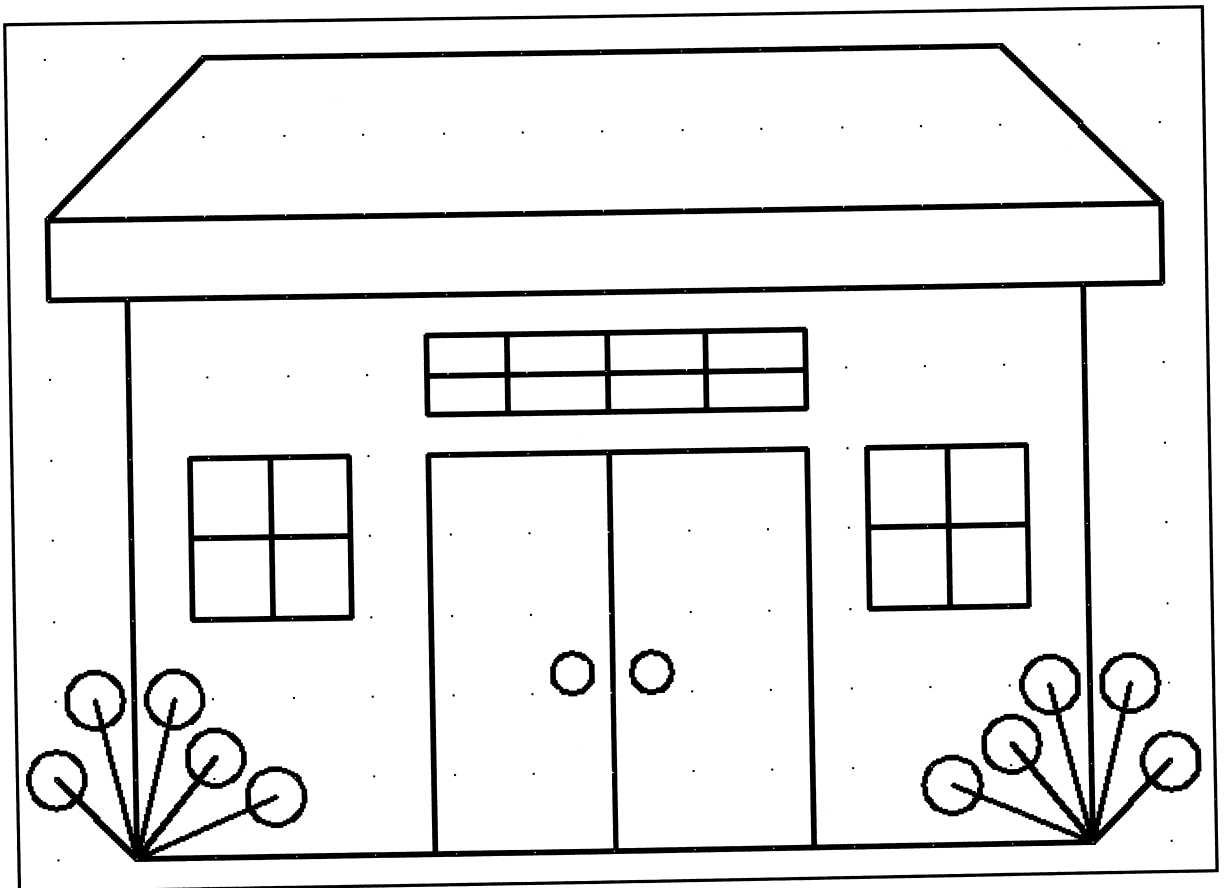

EXERCISE 3E

INSTRUCTIONS:

1. Open **EX3D**. (Use OPEN not NEW to open and existing drawing)
2. Make layer **Object** "current"
(I am having you do that because you can't Freeze or Lock a layer that is current and I want to make sure that none of the layers that you used in the drawing is current.)
3. **Freeze** the following layers: Window and Plants (Do not use erase)
4. **Lock** layer Roof
5. Try to erase any of the roof lines.
You can't because the Roof layer is Locked.
6. **Save** the drawing as: **EX3E**

